

Technical Guide



CARTMEL

Stocked/Paint to Order Colours

Please Note: The information shown in this literature is accurate as at the date of print/release shown on such information but it may be subject to changes after such date. Please therefore ensure that you are viewing the most current product available and check with us if you have any doubt about the suitability of the product or accuracy of the information shown.

CARTMEL PRODUCT OVERVIEW

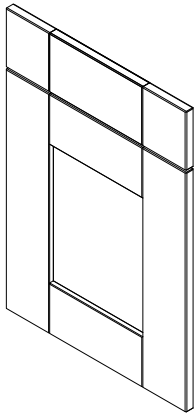
	Product Information	
	Product Description: Product Colours: Product Finish: Base Material: Base Thickness: Covering Material: Edging Material: Edging Colour: Reverse Colour: Product Dimension:	5 piece shaker door with flat centre panel & feature joints (foil door/overpainted foil door) 9 stocked colours/paint to order Matt/matt overpainted, ash woodgrain structure MDF 22mm (end panels are 18mm) Foil/overpainted foil Foil wrapped/overpainted foil wrap, 2mm ABS edge top and bottom Matches face Matches face Standard door and drawer range

Additional Information

Stocked colours: Cartmel stocked colours are foil wrapped and are not hand painted like the Cartmel Paint to Order range. Please note, some of the accessories are timber which are hand painted to match the door colour.

Paint to order colours: The Cartmel Paint to Order door is an overpainted foil door and is available on a lead time. Please note, some of the accessories are timber which are hand painted to match the door colour.

End panels: End panels are 18 mm tickness and have a visible grain structure on both sides. The grain direction is along the longest length. End panels are edged all round.

T&G end panels: T&G on one side, plain on the reverse. Only available in 2400 x 650 x 18mm size.

Curved doors: Cartmel curved doors have a different radius to standard TKC curved doors. Cartmel curved carcasses are available from stock for these doors in the same colours as standard TKC curved carcasses.

IMPORTANT PLEASE NOTE:

While we endeavour to keep the information up to date and correct we do not make any representations or warranties of any kind, express or implied, about the completeness, accuracy, reliability and suitability of the doors and products that appear in this literature.

We aim to showcase as many different items as possible in our kitchen images and therefore some products have been installed and photographed purely to show as many of our product features as possible and they should not be taken as an example of how they are intended to be installed in real kitchen installations.

It is the responsibility of the installer to check the corresponding manufacturer's installation information and the manufacturer's technical information to ensure this is up to date and to ensure that the products can be fitted in a way they are displayed and the products are suitable for your requirements.

We specifically exclude any liability in this regard unless the products are fitted in accordance with the specifications we supply and the manufacturer's installation recommendations are used in a way recommended by the manufacturer and in accordance with the manufacturer's technical information provided.

The information shown in this literature is accurate as at the date of release but it may be subject to changes after such date. Please therefore ensure that you are viewing the most current product information available and check with us if you have any doubt about the suitability of the product or accuracy of the information shown.

We are proud that all our products that we sell are covered by a statutory warranty but this does not stop all our products naturally ageing overtime. **As a result of this natural ageing process we are therefore unable to provide an identical colour finish to the existing products you have purchased from us with any products that we supply you from the same product line.** In such event our liability will be limited to the purchase price paid for the product you are seeking to replace.

Due to the limitations on photographic reproduction, colours may differ slightly from the actual products shown.

Please note that board matches listed with the doors are a suggestion only and better board matches may be available on the market. It is up to the individual to decide on its suitability.

CARTMEL COLOURS STOCKED



ANTHRACITE

Prefix code: 358

Suggested MFC Board Match:

Egger U961/Kronospan 0164/RAL 7016



CASHMERE

Prefix code: 351

Suggested MFC Board Match:

Egger U702/Kronospan 5981



DUST GREY

Prefix code: 355

Suggested MFC Board Match:

Egger U732/Kronospan 0171/RAL 7037



INDIGO

Prefix code: 357

Suggested MFC Board Match:

Egger U599/RAL 5004



IVORY

Prefix code: 80

Suggested MFC Board Match:

Egger U104/Kronospan 0514/RAL 1013



LIGHT GREY

Prefix code: 350

Suggested MFC Board Match:

Egger U708/Kronospan 0191/RAL 7047

CARTMEL COLOURS STOCKED CONT. / PTO



MUSSEL

Prefix code: 352

Suggested MFC Board Match:
Egger U100/Kronospan 5982



SAGE GREEN

Prefix code: 77

Suggested MFC Board Match:
N/A



WHITE

Prefix code: 353

Suggested MFC Board Match:
Egger W1000/Kronospan 8685/RAL 9016

PAINT TO ORDER

Prefix code: 81

23 standard colours (shown below) & bespoke option available with colour match.
Board matches vary, see Trade Index for more info.



NEUTRAL	Super White	White	Porcelain	Chalkstone	Mussel			
EARTHY	Cashmere	Taupe Grey	Pebble Grey	Dakar	Stone Grey	Lava		
GREY	White Grey	Light Grey	Silver Grey	Dust Grey	Onyx Grey			
BLUE & GREEN	Sage Green	French Grey	Fjord	Denim	Smoke Blue	Midnight Blue	Indigo Blue	

CARTMEL PRODUCT INFORMATION

Grain Direction

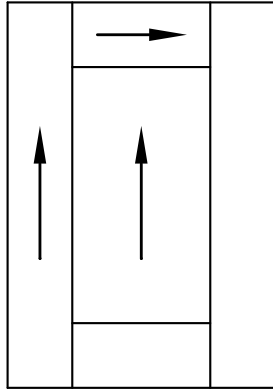

Door Grain Direction

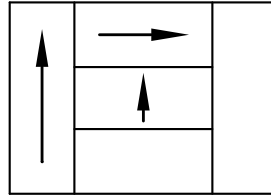

283 / 355mm

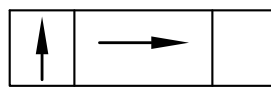

110 / 140 / 175mm

Drawer Grain Direction

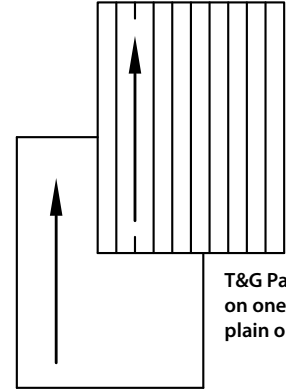

T&G Panel only available in size 2400 x 650mm

T&G Panels are T&G on one side and plain on the reverse

Panel Grain Direction

Door

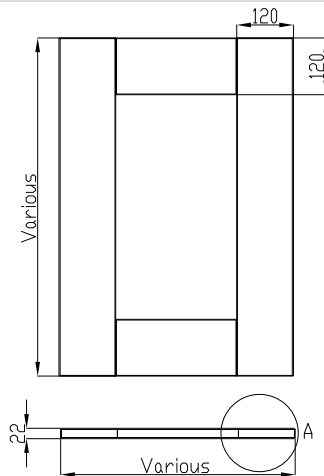
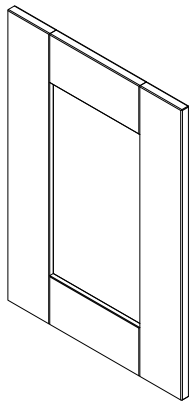

Product Information

5 piece foil wrapped shaker door with flat centre panel & feature joints. Paint to Order doors are overpainted.

715 x 146mm door: This is a slab door with vertical grain direction.

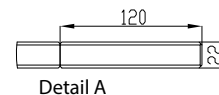

Detail A

Drawer

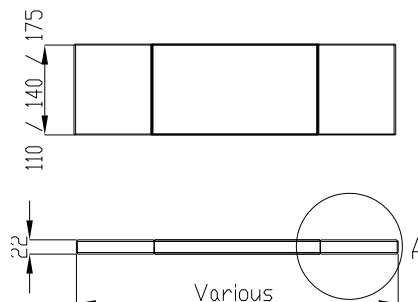
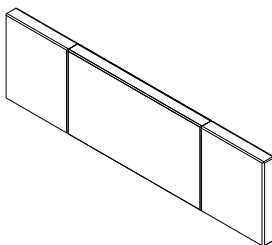

Product Information

3 piece foil wrapped/overpainted foil wrapped drawer, 110/140/175mm (h).

All other drawer heights are based on the door design above.

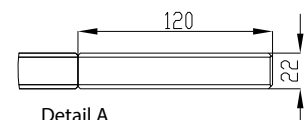

Detail A

CARTMEL PRODUCT INFORMATION

Cartmel Curved Door

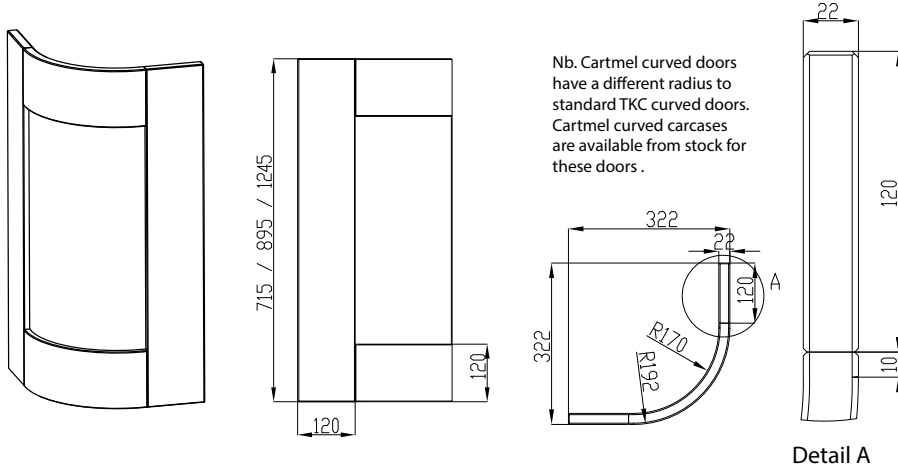

Product Information

5 piece foil wrapped/overpainted foil wrapped curved door with centre panel & feature joints.

Product Codes
 XXXCURVE (715mm)
 XXXCURVE895MM (895mm)
 XXXCURVE1245MM (1245mm)

Curved carcasses are also available for Cartmel curved doors, see below.

Cartmel Curved Carcase (External Curve)

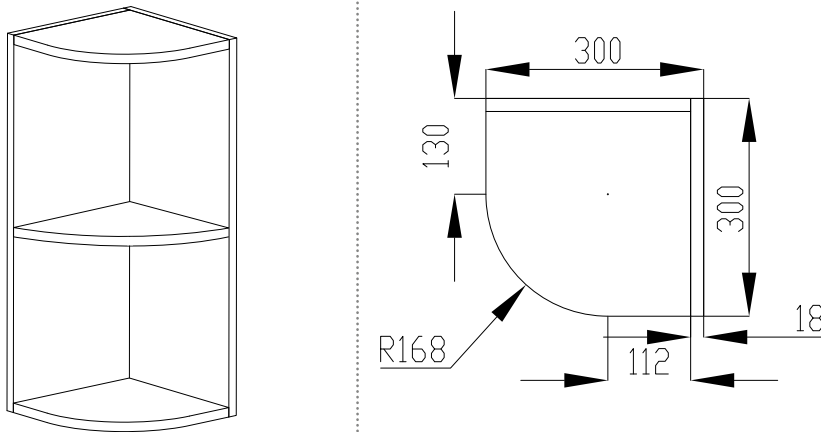

Product Information

Radius carcasse to be used with Cartmel curved doors.

Product Codes
 XXXRADIUSCART (720mm height)
 XXXTRADIUSCART (900mm height)
 XXXETRADIUSCART (1970mm height)

Prefix Codes
 Stone Grey: 87
 Oak: 186
 White: 184
 Ivory: 183
 Light Grey: 187

Nb. legs must be purchased separately for 720mm carcasses if used as a base.

Glazed Frame Door (stocked colours) / Frame Door with clear glass (PTO)

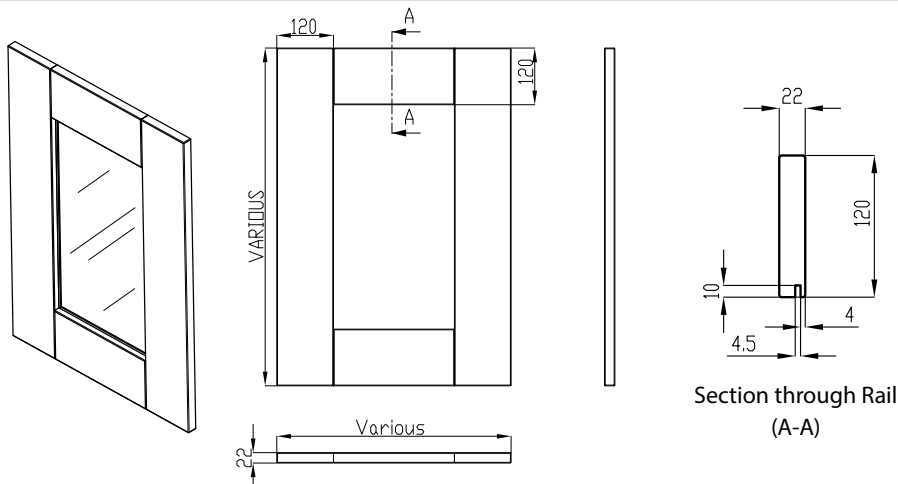

Product Information

Foil wrapped/overpainted foil wrapped door with feature joints.

Stocked colours come ready glazed with 4mm clear toughened glass.

Paint to Order doors are supplied with the glass and frame separate and the customer must arrange for this to be fitted.

CARTMEL PRODUCT INFORMATION

Tangent Cornice

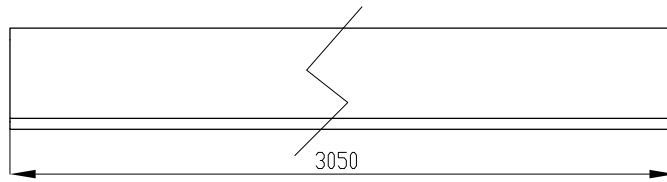
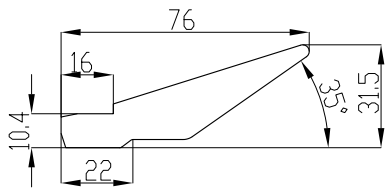
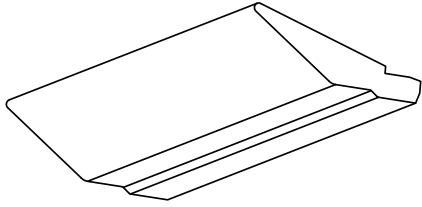

Product Information

Foil wrapped/overpainted foil wrapped MDF.

Product Code

XXXCORNIC

Tangent Pelmet

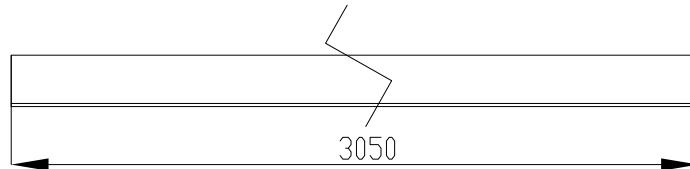
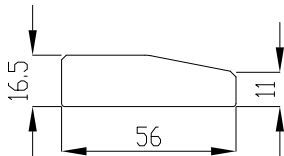
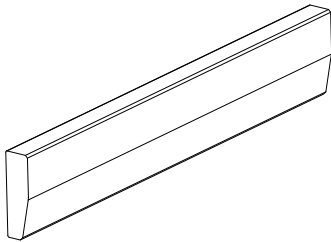

Product Information

Foil wrapped/overpainted foil wrapped MDF.

Product Code

XXXPELMET

Plinth

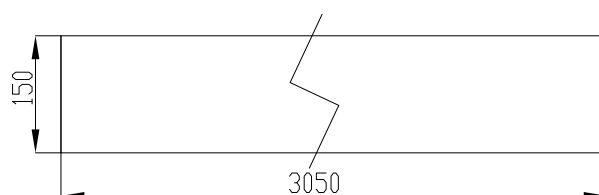
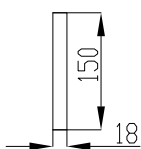
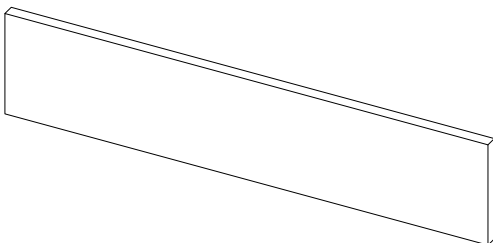

Product Information

Foil wrapped/overpainted foil wrapped face and long edges, chipboard core.

Product Code

XXXPLINTH

CARTMEL PRODUCT INFORMATION

Square End Straight Cornice/Pelmet

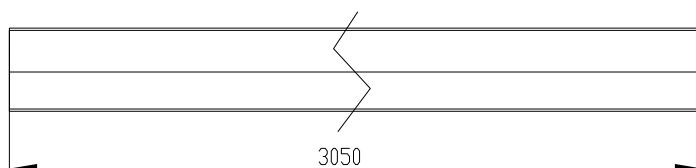
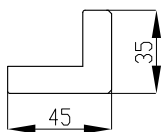
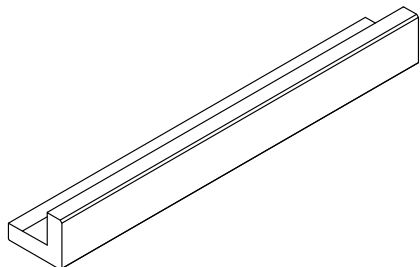

Product Information

Foil wrapped/overpainted foil wrapped MDF.

Product Code

XXXCORNICESQ

Square End Curved Cornice/Pelmet

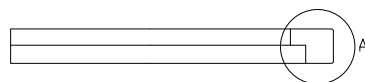
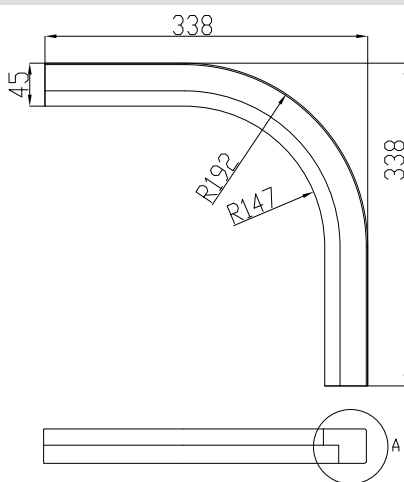
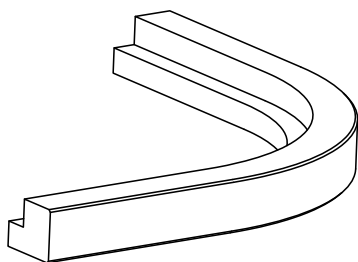

Product Information

Foil wrapped/overpainted foil wrapped MDF.

Product Code

XXXCURVECORNICESQ

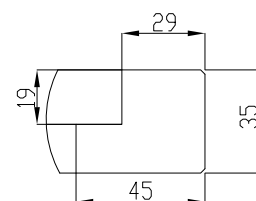

Detail A

Curved Plinth

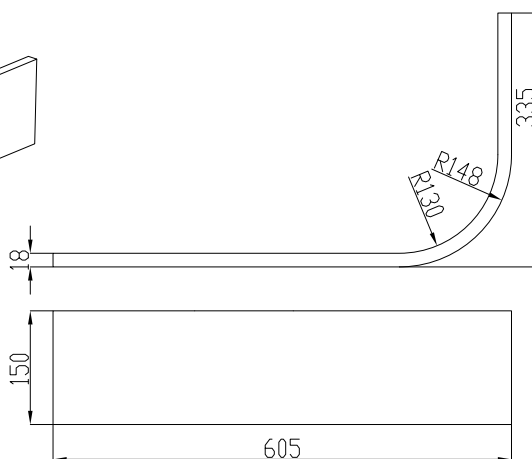
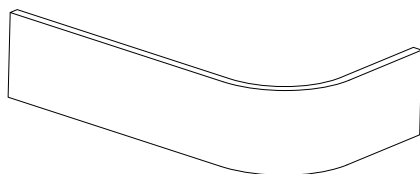

Product Information

Foil wrapped/overpainted foil wrapped MDF.

Product Code

XXXCURVEPLINTH

CARTMEL PRODUCT INFORMATION

Curved Tangent Cornice

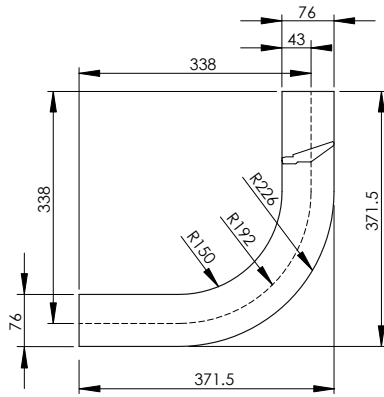
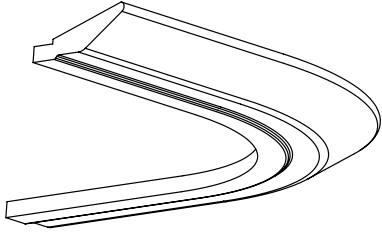

Product Information

Stocked colours are foil wrapped MDF, apart from Ivory and Sage Green which are overpainted foil wrapped MDF to match the door, as are Paint to Order doors.

Product Code

XXXCURVECORNICE

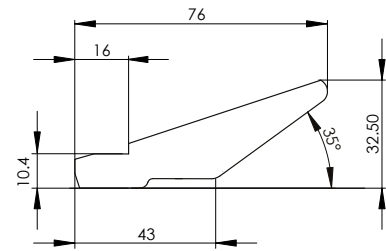

Curved Cornice Block - for use with Curved End Pillar

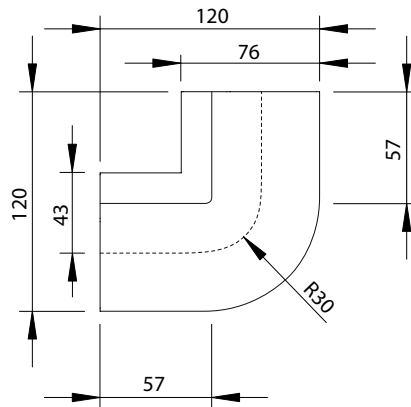
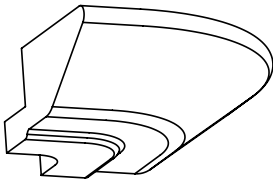

Product Information

Stocked colours are foil wrapped MDF, apart from Ivory and Sage Green which are overpainted foil wrapped MDF to match the door, as are Paint to Order doors.

Product Code

XXXRENDORNICE

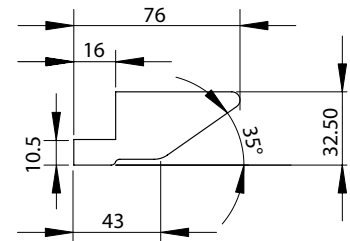

CARTMEL PRODUCT INFORMATION

Straight End Pillar

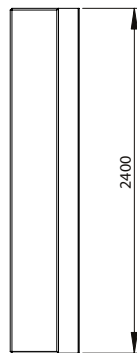
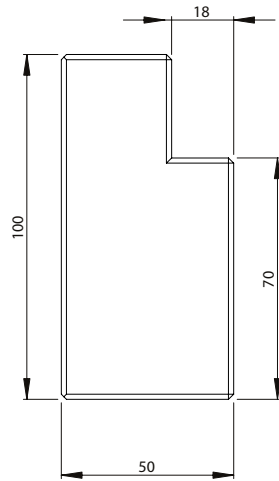
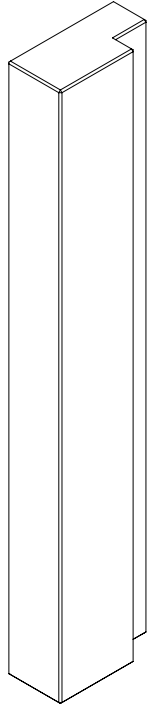

Product Information

Foil wrapped/overpainted foil wrapped MDF.

Product Code

XXXPILLAR

This item can be used in conjunction with an end panel.

Curved End Pillar

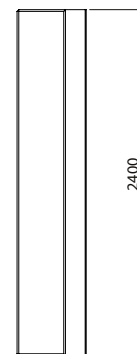
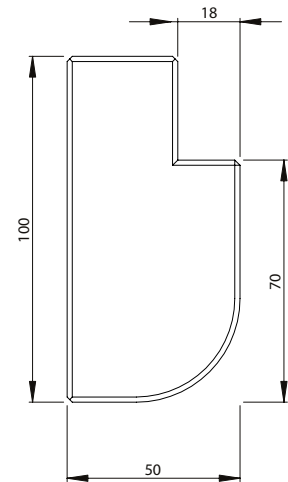
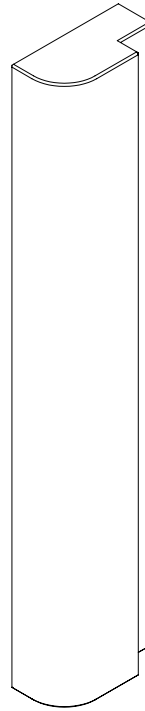

Product Information

Foil wrapped/overpainted foil wrapped MDF.

Product Code

XXXRENDPILLAR

This item can be used in conjunction with an end panel. It can also be used with the Curved Cornice Block (code: XXXRENDCORNIC).

CARTMEL PRODUCT INFORMATION

Corner Posts

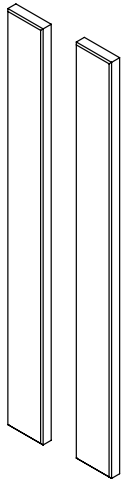

Sold as a pair

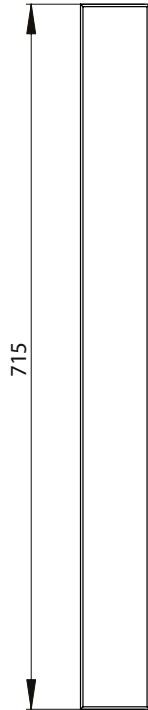
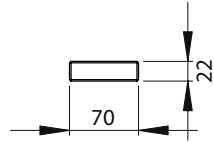

Product Information

Foil wrapped/overpainted foil wrapped MDF.

Product Code

XXXCORNERPOST

Floor Column - painted timber

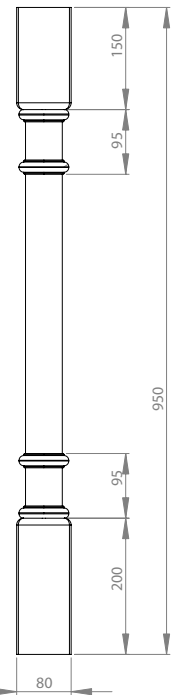
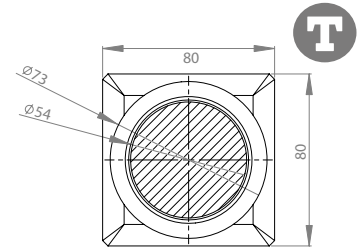
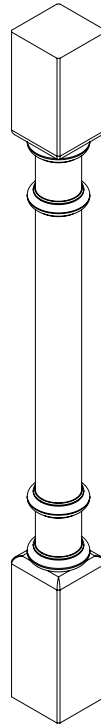

Product Information

Hand painted timber to match door, available from stock.

Product Code

XXXCOLUMN

Plate Rack 1200 - painted timber

Product Information

Hand painted timber to match door, available from stock.

Product Code

XXXPLATE120

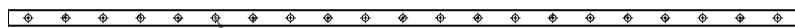
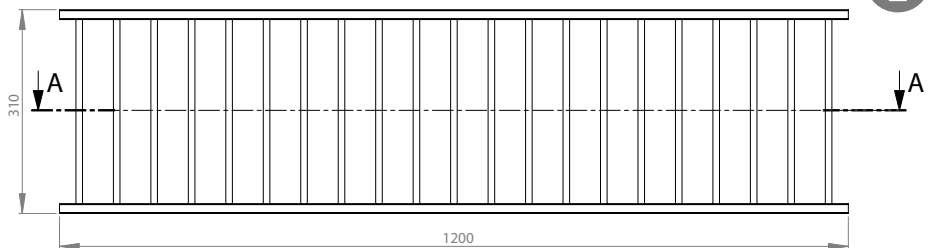
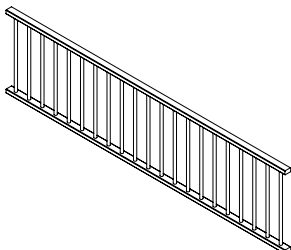

SECTION A-A

CARTMEL PRODUCT INFORMATION

Barrel Pilaster - painted timber

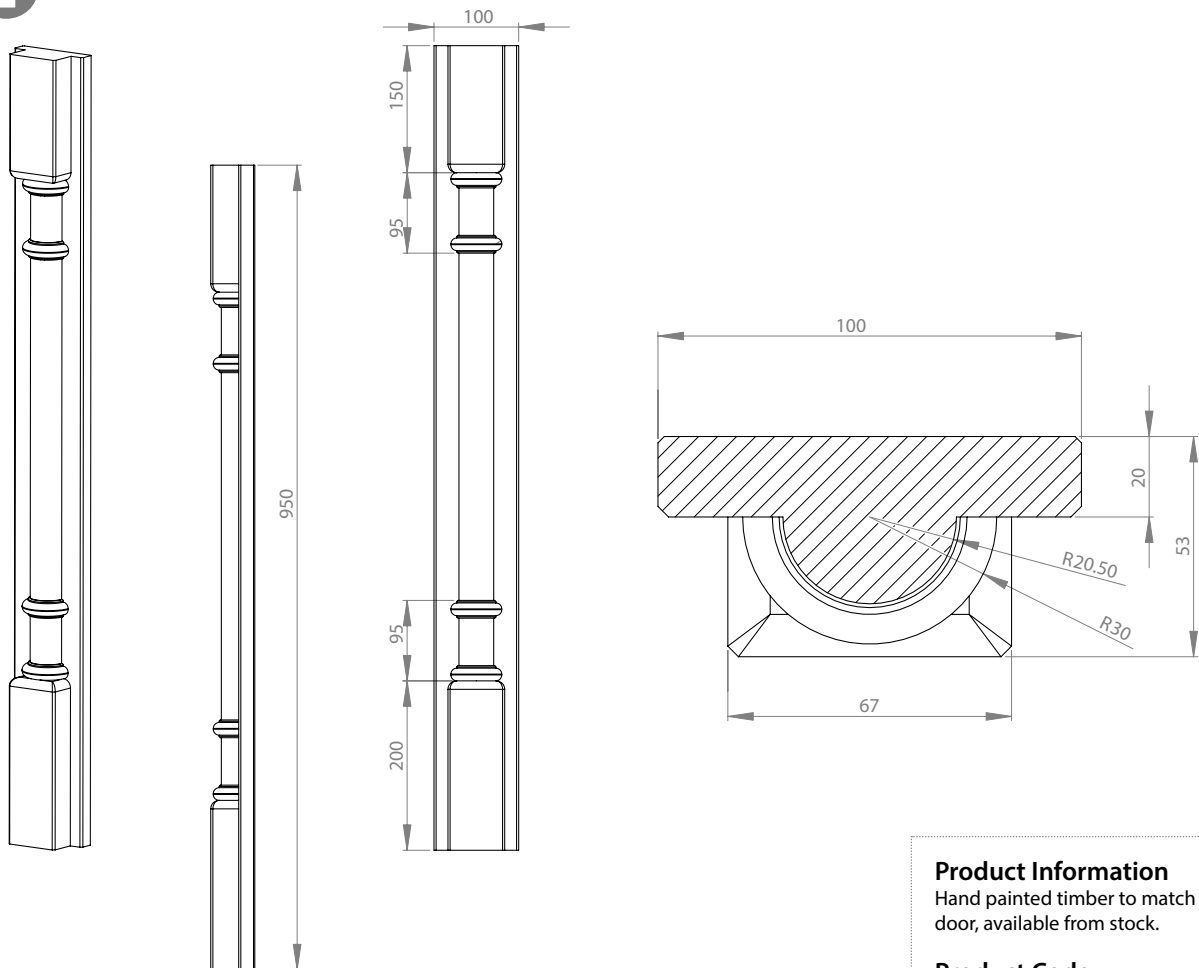

Product Information
Hand painted timber to match door, available from stock.

Product Code
XXXPBARREL

Bottle Rack - painted timber

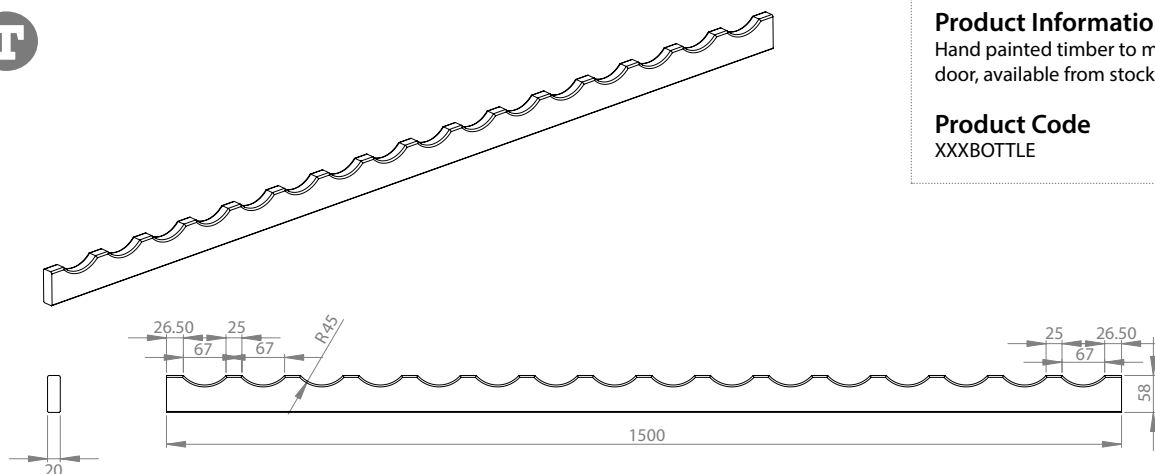

Product Information
Hand painted timber to match door, available from stock.

Product Code
XXXBOTTLE

CARTMEL PRODUCT INFORMATION

Mantel Top

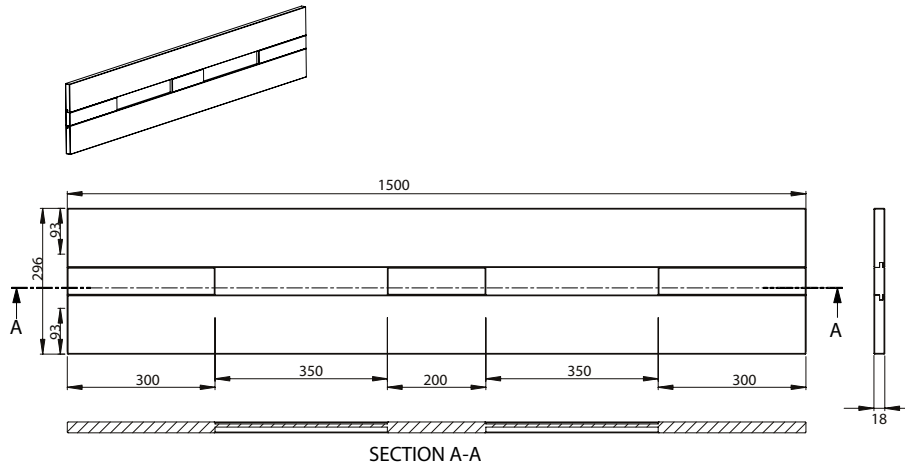

Product Information

7 piece foil wrapped/
overpainted foil wrapped
mantel top with flat centre
panel and feature joints.

Mantel Top Product Code

XXXMANTELTOP

Mantel Side

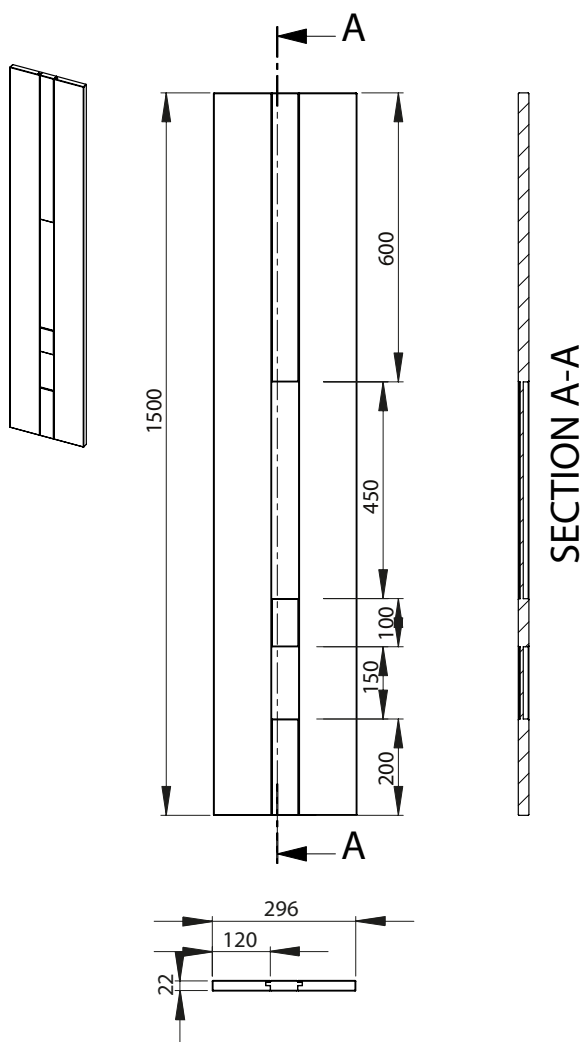

Product Information

7 piece foil wrapped/
overpainted foil wrapped
mantel side with flat centre
panel and feature joints.

Mantel Side Product Code

XXXMANTELSIDE

Mantel Corbel - painted timber

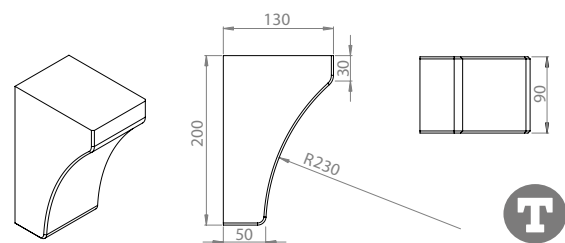

Product Information

Hand painted timber to match
door, available from stock.

Mantel Corbel Product Code

XXXMANTELBKT

CARTMEL PRODUCT INFORMATION

Mantel Shelf

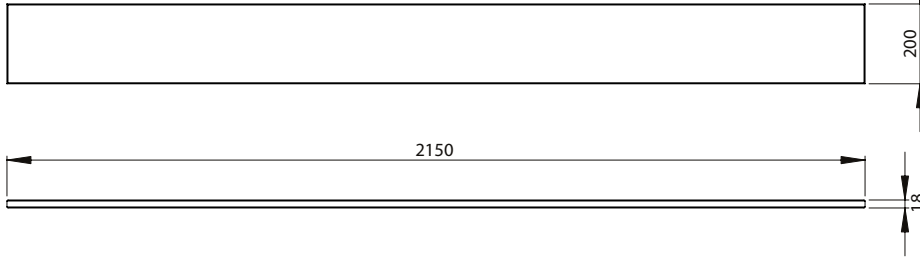
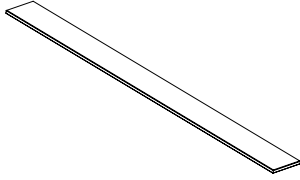

Product Information
Foil wrapped/overpainted foil wrapped MDF.

Mantel Shelf
Product Code
XXXMANTELSHELF

Mantel Kit Complete

Product Information

1 x Mantel Top (1500 x 296mm)
2 x Mantel Side (1500 x 296mm)
2 x Mantel Corbel (200 x 90mm)
1 x Mantel Shelf (2150 x 200mm)

Product Code

XXXMANTELKIT

